



Protocols for Laboratory Verification of Performance of the BIOFIRE® SPOTFIRE® Respiratory/Sore Throat (R/ST) Panel Mini

Laboratory Protocols for Use with ZeptoMetrix NATtrol™ Control Materials

Purpose

The Clinical Laboratory Improvement Amendments (CLIA), passed in 1988, establishes quality standards for all laboratory testing to ensure the accuracy and reliability of patient test results, regardless of where the test is performed. The CLIA regulations include a requirement for verifying the performance specifications of unmodified, moderate complexity tests cleared or approved by the FDA.

This document provides examples of procedures to assist your laboratory in developing a protocol for the verification of the BIOFIRE® SPOTFIRE® Respiratory/Sore Throat (R/ST) Panel Mini performance on the BIOFIRE® SPOTFIRE® System. Multiple verification schemes compatible with the SPOTFIRE R/ST Panel Mini have been designed using non-clinical specimens. The methods described provide positive and negative tests for each organism detected by the SPOTFIRE R/ST Panel Mini Respiratory and Sore Throat menus and may be easily modified or expanded to meet specific criteria. Day-to-day variation is evaluated by testing each sample on two separate days. To evaluate operator-to-operator variation, multiple laboratory technicians may test the same sample. In addition, testing patient samples for verification or to evaluate matrix effects on the performance of the SPOTFIRE R/ST Panel Mini should be done under the guidance of the Laboratory Director, but is not described here.

As per the CLIA regulation, the Laboratory Director is ultimately responsible for ensuring that verification procedures meet the appropriate standards for CLIA and applicable laboratory accrediting agencies.

Intended Use

The BIOFIRE® SPOTFIRE® Respiratory/Sore Throat (R/ST) Panel Mini is a multiplexed polymerase chain reaction (PCR) test intended for use with the BIOFIRE® SPOTFIRE® System for the simultaneous, qualitative detection and identification of multiple respiratory viral and bacterial nucleic acids in nasopharyngeal swab (NPS) specimens obtained from **individuals with signs and symptoms of respiratory tract infection, including COVID-19; (Respiratory menu)** or in throat swab (TS) specimens from **individuals with signs and symptoms of pharyngitis (Sore Throat menu)**.





The following analytes are identified and differentiated using the SPOTFIRE R/ST Panel Mini:

Table 1: SPOTFIRE R/ST Panel Mini Menu.

Respiratory Menu	Sore Throat Menu
Viruses	Viruses
Coronavirus SARS-CoV-2	Human rhinovirus
Human rhinovirus	Influenza A virus
Influenza A virus	Influenza B virus
Influenza B virus	Respiratory syncytial virus
Respiratory syncytial virus	Bacteria
	<i>Streptococcus pyogenes</i> (group A Strep)

The complete intended use statement and additional information about the use of the SPOTFIRE R/ST Panel Mini can be found in the *BIOFIRE® SPOTFIRE® Respiratory/Sore Throat (R/ST) Panel Mini Instructions for Use*.

Performance Verification: Overview

Three different examples of performance verification procedures are described: (1) a Respiratory Protocol for the verification of the SPOTFIRE R/ST Panel Mini performance using the Respiratory Menu; (2) a Sore Throat Protocol for verification of the SPOTFIRE R/ST Panel Mini performance using the Sore Throat Menu; and (3) a Combined Respiratory and Sore Throat Protocol for verification of both the Respiratory and Sore Throat Panel Mini Menus. Each protocol can be used with a different media or expanded to test multiple media to evaluate matrix effects. Refer to the *BIOFIRE® SPOTFIRE® Respiratory/Sore Throat (R/ST) Panel Mini Instructions for Use* for a complete list of acceptable media types. These protocols are examples of procedures to assist your laboratory in developing a protocol for the verification of SPOTFIRE R/ST Panel Mini performance on the SPOTFIRE System.



Note: Transport media may contain non-viable organisms and/or nucleic acids at levels that can be detected by the SPOTFIRE R/ST Panel Mini and may lead to false positive results. Transport media may be screened using the SPOTFIRE R/ST Panel Mini prior to starting the verification procedure. The optimal transport media will be negative for all analytes tested on the SPOTFIRE R/ST Panel Mini.

The procedures have been designed to take advantage of the multiplex nature of the SPOTFIRE R/ST Panel Mini. Verification testing efficiency is maximized by evaluating multiple target organisms in a single test run. The procedures described will generate multiple positive and negative detections for each of the SPOTFIRE R/ST Panel Mini assays. The procedures were developed using the NATrol™ Respiratory/Sore Throat (R/ST) Verification Panel Mini (NATRSTM-BIO) available from ZeptoMetrix, Buffalo, NY.

A SPOTFIRE System is composed of one to four BIOFIRE® SPOTFIRE® Modules connected to a BIOFIRE® SPOTFIRE® Control Station running BIOFIRE® SPOTFIRE® Software. If the laboratory director chooses not to perform the entire verification protocol on each individual module of the SPOTFIRE System, it is advised that test replicates are evenly distributed among the modules. Examples of performance verification workflows using 1 to 4 modules is provided in Figures 1 through 4.





Clinical/patient samples may be used in place of, or in addition to the verification schemes described here to assess clinical sensitivity/specificity and sample matrix effects as part of the performance verification of the SPOTFIRE R/ST Panel Mini.

Note: The laboratory should only perform the verification study with analytes that will be reported using the SPOTFIRE R/ST Panel Mini and with sample types and media that will be used in their laboratory setting.

Table 2. Overview of Verification Protocols.

Verification Protocol	Pool Description	Organisms per pool	Number of Sample Pools	Test Replicates per Pool	Pouches Required ^a	Expected Positive Results ^b	Expected Negative Results	Approximate Days of Testing ^c
Respiratory Menu	Pool 1 (Organisms)	6	2	≥4	8	4 per organism	N/A	≥2
	Pool 2 (No organisms)	0		≥4		N/A	4 per organism	
Sore Throat Menu	Pool 1 (Organisms)	6	2	≥4	8	4 per organism	N/A	≥2
	Pool 2 (No organisms)	0		≥4		N/A	4 per organism	
Combined Respiratory and Sore Throat	Pool 1 (Organisms)	7	2	≥8	16	≥4 per organism	N/A	≥2
	Pool 2 (No organisms)	0		≥8		N/A	≥4 per organism	

^a Pouches required does not include pouches that may be needed for screening transport media.

^b The expected number of positives and negatives per organism is dependent upon sample type and panel menu. Coronavirus SARS-CoV-2 is only reported on the Respiratory Menu, and *S. pyogenes* is only reported on the Sore Throat Menu. Those targets will have fewer positive detections than targets that are present on both menus.

^c Two days is shown to meet day-to-day testing requirements; the number of days can be expanded or decreased, as needed.

Performance Verification: Materials

The following materials may be used to perform the verification procedure:

Table 3. Recommended materials for the verification protocols.

Material	Part Number
BIOFIRE® SPOTFIRE® Respiratory/Sore Throat (R/ST) Panel Mini Test Kit (30 tests)	BioFire Diagnostics, LLC: 424537
BIOFIRE® SPOTFIRE® Respiratory/Sore Throat (R/ST) Panel Mini Instructions for Use	BioFire Diagnostics, LLC: BFR0002-5495
BIOFIRE® SPOTFIRE® Respiratory/Sore Throat (R/ST) Panel Mini Quick Guide	BioFire Diagnostics, LLC: BFR0002-5496
BIOFIRE® SPOTFIRE® System Operator Manual	BioFire Diagnostics, LLC: BFR0001-1641
Control Organisms ^a	ZeptoMetrix NATrol™ Respiratory/Sore Throat (R/ST) Verification Panel Mini: NATRSTM-BIO



Transport Media ^b for Nasopharyngeal swab (NPS)/ Respiratory Menu (e.g., BD™ 3 mL Universal Viral Transport Media or Remel MicroTest™ M4RT® Multi-Microbe Media)	BD: 220220 or Copan: 3C047N or ThermoFisher: R12700
Amies Medium ^b for Throat Swab (TS)/ Sore Throat Menu	Copan Eswab™ 480C
5 mL Sample Tubes	Various manufacturers
Disposable Transfer Pipets, graduated	VWR: 414004-024 (or equivalent)



^a Any appropriate source of organism may be used for verification of any or all of the assays in the SPOTFIRE R/ST Panel Mini. However, when alternate organism sources are used (i.e. not the ZeptoMetrix control material), the sample volumes or pooling schemes suggested in the examples below may need to be adjusted.

^b The media above was validated for use with the SPOTFIRE R/ST Panel Mini. Refer to the Materials Required but Not Provided and the Interference section of the BIOFIRE® SPOTFIRE® Respiratory/Sore Throat (R/ST) Panel Mini Instructions for Use for more details.

Performance Verification: Respiratory Protocol

The Respiratory Protocol evaluates the SPOTFIRE R/ST Panel Mini performance when control material (ZeptoMetrix NATRSTM-BIO) is pooled and combined with an equal volume of transport media or synthetic matrix/negative (provided in the control panel) and tested with the Respiratory Menu. The proposed organism pooling scheme (Table 4) should be followed to obtain the expected number of positive and negative results for each assay in a time and resource-efficient manner.

Verification sample tests should be run by following on-screen instructions for patient sample testing. Refer to the *BIOFIRE® SPOTFIRE® Respiratory/Sore Throat (R/ST) Panel Mini Instructions for Use* or the *BIOFIRE® SPOTFIRE® Respiratory/Sore Throat (R/ST) Panel Mini Quick Guide* for detailed instructions.

-  **Note:** Dilution of ZeptoMetrix control organisms beyond levels proposed in these guidelines may lead to inconsistent results and is not recommended.
-  **Note:** Transport media may contain non-viable organisms and/or nucleic acids at levels that can be detected by the SPOTFIRE R/ST Panel Mini and may lead to false positive results. Transport media may be screened using the SPOTFIRE R/ST Panel Mini (Respiratory Menu) prior to starting the verification procedure. The optimal transport media will be negative for all analytes tested on the SPOTFIRE R/ST Panel Mini Respiratory Menu.

Figures 1 and 2 (below) illustrate workflow schemes for testing 4 replicates per pool for 2 different pools over multiple days. This produces a total of 8 verification sample test runs and provides 4 positive results and 4 negative results per assay. The number of samples tested per day should be determined by the individual laboratory. This testing scheme can be modified to run fewer samples per day based on the number of modules in the SPOTFIRE System. The pooling scheme provides sufficient volume for testing more replicates if desired.

Pooled samples may be stored overnight (or up to 14 days) at refrigeration temperature (2–8°C) for subsequent testing to evaluate day-to-day variation. To evaluate operator-to-operator variation, multiple laboratory technicians may perform testing.





Table 4. Proposed Organism Pooling Scheme for the Verification of the SPOTFIRE R/ST Panel Mini Respiratory Menu.

Verification Panel Organisms (Respiratory Menu)	Approximate Organism Volume	Approximate Volume Transport Media or Negative	Approximate Pool Volume
Pool 1- Viruses			
SARS-CoV-2 (USA-WA1/2020)	0.3 mL	1.8 mL	3.6 mL
Influenza A H1N1pdm (A/NY/02/09)-subtype H1-2009	0.3 mL		
Influenza AH3 (A/Brisbane/10/07)-subtype H3	0.3 mL		
Influenza B (B/Florida/02/06)	0.3 mL		
Rhinovirus 1A	0.3 mL		
Respiratory Syncytial Virus A (RSV A)	0.3 mL		
Pool 2- Negative (No organisms)			
Transport Media or Negative	N/A	1.8 mL	1.8 mL

Example of Respiratory Verification Protocol

The estimated total time to complete this verification example is 2 days for a SPOTFIRE System configured with 1 to 4 modules. Testing over multiple days provides day-to-day variation data; testing with multiple operators provides operator-to-operator variation data; testing multiple replicates of pooled verification material verifies precision of the test system.

Day 1- Respiratory Protocol

- Organize materials needed (Table 3); refer to Table 4 for the pooling scheme. Negativity of transport media may be confirmed by screening on the SPOTFIRE R/ST Panel Mini (Respiratory Menu) prior to starting the verification procedure. Negative vials included in the control panel contain 1.8 mL of synthetic matrix; the control panel contains sufficient volume to complete the protocol described.
- Prepare Pool 1 using the ZeptoMetrix NATRSTM-BIO control materials. Organism vials should be mixed vigorously for 5 seconds prior to preparing each pool.
 - Transfer 0.3 mL of material from the ZeptoMetrix organism vial into a 5 mL tube.
 - Repeat with the second (and subsequent) organisms to combine the appropriate organisms for each pool into a single tube. The combined volume of organisms will be 1.8 mL.
 - Add 1.8 mL transport media or synthetic matrix/negative (as described in Table 4) to the tube containing the organism pool (step b). The volume of transport media/ negative should be the same as the organism pool volume. The final volume of Pool 1 will be approximately 3.6 mL.
- Pool 2 consists of transport media or negative control/ synthetic matrix (provided in the control panel), but no organisms. This pool is used to provide negative detections for the SPOTFIRE R/ST Panel Mini targets. Replicate testing can be done directly from the tube of transport media or synthetic matrix/negative, no mixing is required.



- Test 2 replicates from each sample pool (Figure 1: test replicates A and B from Pools 1 and 2) using the Respiratory Menu. Ensure Pool 1 is well mixed prior to removing a sample for testing. Replicate samples A and B should be tested in a single day by different operators to evaluate operator-to-operator variance. Refer to Figure 2 (below) for suggested workflows depending upon the module configuration in the verification study.

Note: For each sample, follow instructions in the *BIOFIRE® SPOTFIRE® Respiratory/Sore Throat (R/ST) Panel Mini Instructions for Use* or the *BIOFIRE® SPOTFIRE® Respiratory/Sore Throat (R/ST) Panel Mini Quick Guide* for pouch preparation, pouch hydration, sample loading, and sample testing. Verification sample tests should be run by following on-screen instructions for patient sample pouch testing.

- Refrigerate samples (2–8°C) for up to 14 days for the evaluation of day-to-day variation.

Note: The proposed organism pooling scheme, described in Table 4, provides sufficient material for running samples as described in Figure 1. The volume is sufficient for testing more samples if desired.

Day 2 - Respiratory Protocol

To evaluate day-to-day variation, test additional replicates from the pools prepared on Day 1 by repeating Step 4 above (Figure 1: test replicates C and D from Pools 1 and 2).

Note: A Verification Record for the SPOTFIRE R/ST Mini Respiratory Menu protocol is provided and may serve as a template for recording your results.

Figure 1. Verification Protocol Workflow for Testing One Menu (Respiratory or Sore Throat) over Two Days.

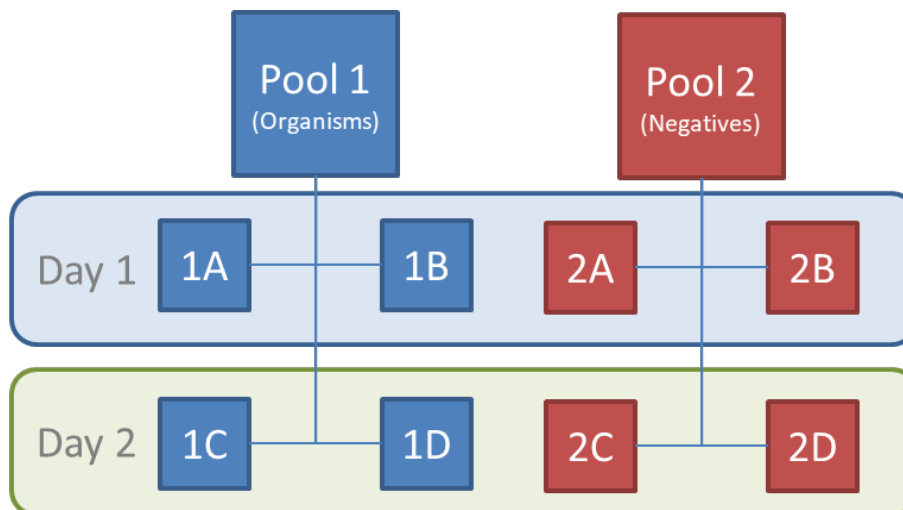



Figure 2. Examples of the Verification Workflow for Testing One Menu (Respiratory or Sore Throat) over two days with different SPOTFIRE System Module configurations.

Verification with One Module		
Testing Day	Module 1	
Day 1	Pool 1A/ Operator 1	Pool 2A/ Operator 1
	Pool 1B/ Operator 2	Pool 2B/ Operator 2
Day 2	Pool 1C/ Operator 1	Pool 2C/ Operator 1
	Pool 1D/ Operator 2	Pool 2D/ Operator 2

Verification with Two Modules				
Testing Day	Module 1		Module 2	
Day 1	Pool 1A/ Operator 1	Pool 2A/ Operator 1	Pool 1B/ Operator 2	Pool 2B/ Operator 2
Day 2	Pool 1D/ Operator 2	Pool 2D/ Operator 2	Pool 1C/ Operator 1	Pool 2C/ Operator 1

Verification with Three Modules						
Testing Day	Module 1		Module 2		Module 3	
Day 1	Pool 1A/ Operator 1	Pool 2B/ Operator 2	Pool 2A/ Operator 1		Pool 1B/ Operator 2	
Day 2	Pool 1D/ Operator 2		Pool 1C/ Operator 1	Pool 2D/ Operator 2		Pool 2C/ Operator 1



Verification with Four Modules				
Testing Day	Module 1	Module 2	Module 3	Module 4
Day 1	Pool 1A/ Operator 1	Pool 1B/ Operator 2	Pool 2A/ Operator 1	Pool 2B/ Operator 2
Day 2	Pool 2D/ Operator 2	Pool 2C/ Operator 1	Pool 1D/ Operator 2	Pool 1C/ Operator 1



Performance Verification: Sore Throat Protocol

The Sore Throat Protocol evaluates the SPOTFIRE R/ST Panel Mini performance when control material (ZeptoMetrix NATRSTM-BIO) is pooled and combined with an equal volume of transport media, such as Amies, or negative/synthetic matrix (provided in the control panel) and tested with the Sore Throat Menu. The proposed organism pooling scheme (Table 5) should be followed to obtain the expected number of positive and negative results for each assay in a time and resource-efficient manner.

Verification sample tests should be run by following on-screen instructions for patient sample testing. Refer to the *BIOFIRE® SPOTFIRE® Respiratory/Sore Throat (R/ST) Panel Mini Instructions for Use* or the *BIOFIRE® SPOTFIRE® Respiratory/Sore Throat (R/ST) Panel Mini Quick Guide* for detailed instructions.

-  **Note:** Dilution of ZeptoMetrix control organisms beyond levels proposed in these guidelines may lead to inconsistent results and is not recommended.
-  **Note:** Transport media (including Amies) may contain non-viable organisms and/or nucleic acids at levels that can be detected by the SPOTFIRE R/ST Panel Mini and may lead to false positive results. Transport media may be screened using the SPOTFIRE R/ST Panel Mini (Sore Throat Menu) prior to starting the verification procedure. The optimal transport media will be negative for all analytes tested on the SPOTFIRE R/ST Panel Mini Sore Throat Menu.

Figures 1 and 2 (above) illustrate workflow schemes for testing 4 replicates per pool for 2 different pools over multiple days. This produces a total of 8 verification sample test runs and provides 4 positive results and 4 negative results per assay. The number of samples tested per day should be determined by the individual laboratory. This testing scheme can be modified to run fewer samples per day based on the number of modules in the SPOTFIRE System. The pooling scheme provides sufficient volume for testing more replicates if desired.

Pooled samples may be stored overnight (or up to 14 days) at refrigeration temperature (2–8°C) for subsequent testing to evaluate day-to-day variation. To evaluate operator-to-operator variation, multiple laboratory operators may perform testing.

Table 5. Proposed Organism Pooling Scheme for the Verification of the SPOTFIRE R/ST Panel Mini Sore Throat Menu.

Verification Panel Organisms (Sore Throat Menu)	Approximate Organism Volume	Approximate Volume Transport Media or Negative	Approximate Pool Volume
Pool 1- Viruses and Bacteria			
Influenza A H1N1pdm (A/NY/02/09)-subtype H1-2009	0.3 mL	1.8 mL	3.6 mL
Influenza AH3 (A/Brisbane/10/07)-subtype H3	0.3 mL		
Influenza B (B/Florida/02/06)	0.3 mL		
Rhinovirus 1A	0.3 mL		
Respiratory Syncytial Virus A (RSV A)	0.3 mL		
<i>Streptococcus pyogenes</i>	0.3 mL		
Pool 2- Negative (No organisms)			
Transport media or Negative	N/A	1.8 mL	1.8 mL



Example of Protocol for Sore Throat Verification

The estimated total time to complete this verification example is 2 days for a SPOTFIRE System configured with 1 to 4 modules. Testing over multiple days provides day-to-day variation data; testing with multiple operators provides operator-to-operator variation data; testing multiple replicates of pooled verification material verifies precision of the test system.

Day 1-Sore Throat Protocol

1. Organize materials needed (Table 3); refer to Table 5 for the pooling scheme. Negativity of transport media/Amies may be confirmed by screening on the SPOTFIRE R/ST Panel Mini prior to starting the verification procedure. Negative vials included in the control panel contain 1.8 mL of synthetic matrix; the control panel contains sufficient volume to complete the protocol described.
2. Prepare Pool 1 using the ZeptoMetrix NATRSTM-BIO control materials. Organism vials should be mixed vigorously for 5 seconds prior to preparing each pool.
 - a. Transfer 0.3 mL of material from the ZeptoMetrix organism vial into a 5 mL tube.
 - b. Repeat with the second (and subsequent) organisms to combine the appropriate organisms for each pool into a single tube. The combined volume of organisms will be 1.8 mL.
 - c. Add 1.8 mL transport media or synthetic matrix/negative (as described in Table 5) to the tube containing the organism pool (step b). The volume of transport media/ negative should be the same as the organism pool volume. The final volume of Pool 1 will be approximately 3.6 mL.
3. Pool 2 consists of transport media/Amies or negative control/ synthetic matrix (provided in the control panel), but no organisms. This pool is used to provide negative detections for the SPOTFIRE R/ST Panel Mini targets. Replicate testing can be done directly from the tube of transport media or synthetic matrix/negative, no mixing is required.
4. Test 2 replicates from each sample pool (Figure 1: test replicates A and B from Pools 1 and 2) using the Sore Throat Menu. Ensure the Pool 1 is well mixed prior to removing a sample for testing. Replicate samples A and B should be tested in a single day by different operators to evaluate operator-to-operator variance. Refer to Figure 2 (above) for suggested workflows depending upon the module configuration in the verification study.



Note: For each sample, follow instructions in the *BIOFIRE® SPOTFIRE® Respiratory/Sore Throat (R/ST) Panel Mini Instructions for Use* or the *BIOFIRE® SPOTFIRE® Respiratory/Sore Throat (R/ST) Panel Mini Quick Guide* for pouch preparation, pouch hydration, sample loading, and sample testing. Verification sample tests should be run by following on-screen instructions for patient sample pouch testing.

5. Refrigerate samples (2–8°C) for up to 14 days for the evaluation of day-to-day variation.



Note: The proposed organism pooling scheme, described in Table 5, provides sufficient material for running samples as described in Figure 1 (above). The volume is sufficient for testing more samples if desired.





Day 2- Sore Throat Protocol

To evaluate day-to-day variation, test additional replicates from the pools prepared on Day 1 by repeating Step 4 above (Figure 1: test replicates C and D from Pools 1 and 2).



Note: A Verification Record for the SPOTFIRE R/ST Mini Sore Throat Menu protocol is provided and may serve as a template for recording your results.

Performance Verification: Combined Protocol for Respiratory and Sore Throat

The combined verification protocol for Respiratory and Sore Throat Menus evaluates the SPOTFIRE R/ST Panel Mini performance when sample material (ZeptoMetrix NATRSTM-BIO) is pooled and combined with an equal volume of transport media, or negative/synthetic matrix (provided in the control panel) and tested with the both the Respiratory and Sore Throat Menus. The proposed organism pooling scheme (Table 6) should be followed to obtain the expected number of positive and negative results for each assay in a time and resource-efficient manner.

Verification sample tests should be run by following on-screen instructions for patient sample testing. Refer to the *BIOFIRE® SPOTFIRE® Respiratory/Sore Throat (R/ST) Panel Mini Instructions for Use* or the *BIOFIRE® SPOTFIRE® Respiratory/Sore Throat (R/ST) Panel Mini Quick Guide* for detailed instructions.



Note: Dilution of ZeptoMetrix control organisms beyond levels proposed in these guidelines may lead to inconsistent results and is not recommended.



Note: Transport media may contain non-viable organisms and/or nucleic acids at levels that can be detected by the SPOTFIRE R/ST Panel Mini and may lead to false positive results. Transport media may be screened using the SPOTFIRE R/ST Panel Mini (Respiratory and Sore Throat Menus) prior to starting the verification procedure. The optimal transport media will be negative for all analytes tested on the SPOTFIRE R/ST Panel Mini.

Figures 3 and 4 (below) illustrate workflow schemes for testing 8 replicates per pool for 2 different pools over multiple days. This produces a total of 16 verification sample test runs and provides at least 4 positive results and 4 negative results per assay. The expected number of positives and negatives per organism is dependent upon sample type and panel menu. Coronavirus SARS-CoV-2 is only reported on the Respiratory Menu, and *Streptococcus pyogenes* is only reported on the Sore Throat Menu. Those targets will have fewer positive detections than targets that are present on both menus. The number of samples tested per day should be determined by the individual laboratory. This testing scheme can be modified to run fewer samples per day based on the number of modules in the SPOTFIRE System. The pooling scheme provides sufficient volume for testing more replicates if desired.

Pooled samples may be stored overnight (or up to 14 days) at refrigeration temperature (2–8°C) for subsequent testing to evaluate day-to-day variation. To evaluate operator-to-operator variation, multiple laboratory operators may perform testing.



Table 6. Proposed Organism Pooling Scheme for the Combined Verification of the SPOTFIRE R/ST Panel Mini.

Verification Panel Organisms Respiratory and Sore Throat Menus, unless noted	Approximate Organism Volume	Approximate Volume Transport Media or Negative	Approximate Pool Volume
Pool 1- Viruses and Bacteria			
SARS-CoV-2 (USA-WA1/2020) (Respiratory Menu)	0.3 mL	2.1 mL	4.2 mL
Influenza A H1N1pdm (A/NY/02/09)-subtype H1-2009	0.3 mL		
Influenza AH3 (A/Brisbane/10/07)-subtype H3	0.3 mL		
Influenza B (B/Florida/02/06)	0.3 mL		
Rhinovirus 1A	0.3 mL		
Respiratory Syncytial Virus A (RSV A)	0.3 mL		
<i>Streptococcus pyogenes</i> (Sore Throat Menu)	0.3 mL		
Pool 2- Negative (No organisms)			
Transport media or Negative	N/A	3.0 mL	3.0 mL

Example of a Combined Protocol for Respiratory and Sore Throat Verification

This verification protocol example can be completed in 2 or more days depending on the number of modules in the SPOTFIRE System configuration and the laboratory's work schedule. Testing over multiple days provides day-to-day variation data; testing with multiple operators provides operator-to-operator variation data; testing multiple replicates of pooled verification material verifies precision of the test system.



Note: If the laboratory verification study will include multiple types of transport media, see the section *Expanding or Modifying the Protocol* below.

Day 1- Combined Respiratory and Sore Throat Protocol

- Organize materials needed (Table 3); refer to Table 6 for the pooling scheme. Negativity of transport media/Amies may be confirmed by screening on the SPOTFIRE R/ST Panel Mini prior to starting the verification procedure. Negative vials included in the control panel contain 1.8 mL of synthetic matrix; the control panel contains sufficient volume to complete the protocol described.
- Prepare Pool 1 using the ZeptoMetrix NATRSTM-BIO control materials. Organism vials should be mixed vigorously for 5 seconds prior to preparing each pool.
 - Transfer 0.3 mL of material from the ZeptoMetrix organism vial into a 5 mL tube.
 - Repeat with the second (and subsequent) organisms to combine the appropriate organisms for each pool into a single tube. The combined volume of organisms for each pool will be 2.1 mL.
 - Add 2.1 mL transport media or synthetic matrix/negative (as described in Table 6) to the tube containing the organism pool (step b). The volume of transport media/ negative should be the same as the organism pool volume. The final volume of Pool 1 will be approximately 4.2 mL.



3. Pool 2 consists of transport media or negative control/ synthetic matrix (provided in the control panel), but no organisms. This pool is used to provide negative detections for the SPOTFIRE R/ST Panel Mini targets. Replicate testing can be done directly from the tube of transport media or synthetic matrix/negative, no mixing is required. More than one tube of negative control may be needed.
4. Test 2 replicates from a single sample pool (Figure 3: Pool 1 replicates A and B) using the Respiratory Menu and 2 replicates (Figure 3: Pool 1 replicates C and D) using the Sore Throat Menu. Ensure Pool 1 is well mixed prior to removing a sample for testing. The replicate samples should be tested in a single day by different operators to evaluate operator-to-operator variance. Refer to Figure 4 for suggested workflows depending upon the module configuration in the verification study.



Note: For each sample, follow instructions in the *BIOFIRE® SPOTFIRE® Respiratory/Sore Throat (R/ST) Panel Mini Instructions for Use* or the *BIOFIRE® SPOTFIRE® Respiratory/Sore Throat (R/ST) Panel Mini Quick Guide* for pouch preparation, pouch hydration, sample loading, and sample testing. Verification sample tests should be run by following on-screen instructions for patient sample pouch testing.

5. Repeat Step 4 for the remaining sample replicates to be tested that day (Figure 3: Pool 2 replicates A and B using the Respiratory Menu and Pool 2 replicates C and D using the Sore Throat Menu).
6. Refrigerate samples (2–8°C) for up to 14 days for the evaluation of day-to-day variation.



Note: The proposed organism pooling scheme, described in Table 6, provides sufficient material for running samples as described in Figure 3. The volume is sufficient for testing more samples if desired.

Day 2- Combined Respiratory and Sore Throat Protocol

To evaluate day-to-day variation, test additional replicates from the pools prepared on Day 1 by repeating Step 4 above (Figure 3: test replicates E and F from Pools 1 and 2 using the Respiratory Menu and test replicates G and H from Pools 1 and 2 using the Sore Throat Menu).



Note: A SPOTFIRE Respiratory and Sore Throat Menu Verification Record is provided and may serve as a template for recording your results.





Figure 3. Verification Protocol Workflow for Testing Respiratory and Sore Throat Menus over Two Days.

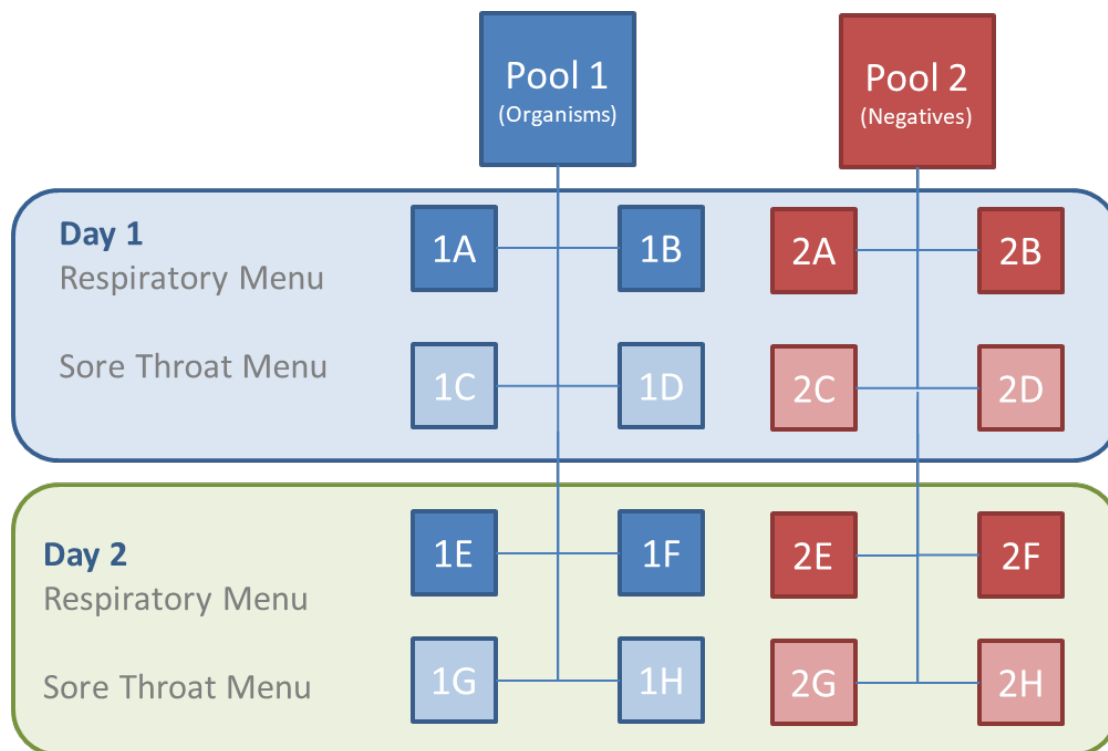

Figure 4. Examples of Combined Verification Workflow testing over two days with different SPOTFIRE module configurations.

Combined Verification with 1 module		Module 1			
Day 1	Respiratory Menu	Pool 1A/ Operator 1	Pool 1B/ Operator 2	Pool 2A/ Operator 1	Pool 2B/ Operator 2
	Sore Throat Menu	Pool 1C/ Operator 1	Pool 1D/ Operator 2	Pool 2C/ Operator 1	Pool 2D/ Operator 2
Day 2	Respiratory Menu	Pool 1E/ Operator 1	Pool 1F/ Operator 2	Pool 2E/ Operator 1	Pool 2F/ Operator 2
	Sore Throat Menu	Pool 1G/ Operator 1	Pool 1H/ Operator 2	Pool 2G/ Operator 1	Pool 2H/ Operator 2





Combined Verification with 2 modules		Module 1		Module 2	
Day 1	Respiratory Menu	Pool 1A/ Operator 1	Pool 2A/ Operator 1	Pool 1B/ Operator 2	Pool 2B/ Operator 2
	Sore Throat Menu	Pool 1C/ Operator 1	Pool 2C/ Operator 1	Pool 1D/ Operator 2	Pool 2D/ Operator 2
Day 2	Respiratory Menu	Pool 1F/ Operator 2	Pool 2F/ Operator 2	Pool 1E/ Operator 1	Pool 2E/ Operator 1
	Sore Throat Menu	Pool 1H/ Operator 2	Pool 2H/ Operator 2	Pool 1G/ Operator 1	Pool 2G/ Operator 1

Combined Verification with 3 modules		Module 1		Module 2		Module 3	
Day 1	Respiratory Menu	Pool 1A/ Operator 1	Pool 2A/ Operator 1		Pool 2B/ Operator 2	Pool 1B/ Operator 2	
	Sore Throat Menu	Pool 1C/ Operator 1		Pool 1D/ Operator 2	Pool 2D/ Operator 2	Pool 2C/ Operator 1	
Day 2	Respiratory Menu	Pool 1F/ Operator 2	Pool 2F/ Operator 2	Pool 1E/ Operator 1		Pool 2E/ Operator 1	
	Sore Throat Menu			Pool 1H/ Operator 2	Pool 2G/ Operator 1	Pool 1G/ Operator 1	Pool 2H/ Operator 2



Combined Verification with 4 modules		Module 1	Module 2	Module 3	Module 4
Day 1	Respiratory Menu	Pool 1A/ Operator 1	Pool 1B/ Operator 2	Pool 2A/ Operator 1	Pool 2B/ Operator 2
	Sore Throat Menu	Pool 1D/ Operator 2	Pool 1C/ Operator 1	Pool 2D/ Operator 2	Pool 2C/ Operator 1
Day 2	Respiratory Menu	Pool 2F/ Operator 2	Pool 2E/ Operator 1	Pool 1F/ Operator 2	Pool 1E/ Operator 1
	Sore Throat Menu	Pool 2G/ Operator 1	Pool 2H/ Operator 2	Pool 1G/ Operator 1	Pool 1H/ Operator 2

Expanding or Modifying the Protocol

The protocols described above can be expanded by increasing the number of tests from Pool 1. Pool 1 contains sufficient volume for testing additional replicates. To test additional media types, prepare additional organism pools using the control material (NATRSTM-BIO) following Steps 1-6 above.





-  **Note:** The laboratory should perform the verification study with specimen types and media that will be used with the SPOTFIRE R/ST Panel Mini in their laboratory setting.
-  **Note:** Expanding the pool volume may require larger sample tubes to accommodate the increased volume.

Verification of Loaner, Repaired, Refurbished and Permanent Replacement Modules

If it becomes necessary to verify the performance of a loaner, repaired, refurbished, or permanent replacement module, the following protocol may serve as a guideline but should be verified by the Laboratory Director.

1. Select an appropriate number of specimens and/or proficiency samples (any combination of positives and negatives) previously tested on the SPOTFIRE Respiratory/Sore Throat Panel Mini. The Laboratory Director should determine the appropriate number of samples to test. Proficiency samples should not be pooled or diluted.
2. Select a set of controls that verify detection of all targets on the SPOTFIRE R/ST Panel Mini.
3. Test the selected samples on the loaner, repaired, or permanent replacement module and document the results.

Technical Support Contact Information

bioMérieux is dedicated to providing the best customer support available. If you have any questions or concerns about this process, please contact the BIOFIRE Technical Support team for assistance.

BIOFIRE Technical Support
Email: biofiresupport@biomerieux.com
Phone: +1-801-736-6354, select Option 5

*All product names, trademarks and registered trademarks are property of their respective owners.



SPOTFIRE R/ST Panel Mini: Respiratory Menu Verification Record

BIOFIRE® SPOTFIRE® Respiratory/Sore Throat (R/ST) Panel Mini Verification Record- Respiratory Menu

SPOTFIRE R/ST Mini Kit Part # _____ Module Serial # _____
 SPOTFIRE R/ST Mini Kit Lot # _____ Module Serial # _____
 Media Type _____ Media Lot # _____

Organism and Representative Strain		Replicate Testing- Record Organism Detections								Respiratory Summary					
		1-A	1-B	1-C	1-D	2-A	2-B	2-C	2-D	# Positives	# Negatives	# Operators	# Days	# Modules	Patient Samples?
Pool 1	Positive: Multiple Organisms														
	Coronavirus SARS-CoV-2														
	Human rhinovirus														
	Influenza A virus	subtype H1-2009													
		subtype H3													
	Influenza B virus														
	Respiratory syncytial virus														
Pool 2	Negative														
	No organism detections														

Reviewed by: _____
 Signature





SPOTFIRE R/ST Panel Mini: Sore Throat Menu Verification Record

BIOFIRE® SPOTFIRE® Respiratory/Sore Throat (R/ST) Panel Mini Verification Record- Sore Throat Menu

SPOTFIRE R/ST Mini Kit Part # _____ Module Serial # _____
 SPOTFIRE R/ST Mini Kit Lot # _____ Module Serial # _____
 Media Type _____ Media Lot # _____

Organism and Representative Strain		Replicate Testing- Record Organism Detections								Sore Throat Summary					
		1-A	1-B	1-C	1-D	2-A	2-B	2-C	2-D	# Positives	# Negatives	# Operators	# Days	# Modules	Patient Samples?
Pool 1	Positive: Multiple Organisms														
	Human rhinovirus														
	Influenza A virus														
	subtype H1-2009														
	subtype H3														
	Influenza B virus														
	Respiratory syncytial virus														
	<i>Streptococcus pyogenes</i> (group A Strep)														
Pool 2	Negative														
	No organism detections														

Reviewed by: _____
 Signature





SPOTFIRE R/ST Panel Mini: Combined Respiratory/Sore Throat Menu Verification Record- Respiratory Menu Detections

BIOFIRE® SPOTFIRE® Respiratory/Sore Throat (R/ST) Panel Mini Verification Record- Respiratory Menu

SPOTFIRE R/ST Mini Kit Part # _____	Module Serial # _____
SPOTFIRE R/ST Mini Kit Lot # _____	Module Serial # _____
Media Type _____	Media Lot # _____

Organism and Representative Strain		Replicate Testing- Record Organism Detections								Respiratory Summary					
		1-A	1-B	1-C	1-D	2-A	2-B	2-C	2-D	# Positives	# Negatives	# Operators	# Days	# Modules	Patient Samples?
Pool 1	Positive: Multiple Organisms														
	Coronavirus SARS-CoV-2														
	Human rhinovirus														
	Influenza A virus														
	subtype H1-2009														
	subtype H3														
	Influenza B virus														
Respiratory syncytial virus															
<i>Streptococcus pyogenes</i> (group A Strep)	N/A	N/A	N/A	N/A	N/A	N/A	N/A	N/A	N/A	N/A	N/A	N/A	N/A	N/A	
Pool 2	Negative														
	No organism detections														

Reviewed by: _____
Signature





SPOTFIRE R/ST Panel Mini: Combined Respiratory/Sore Throat Menu Verification Record- Sore Throat Menu Detections

BIOFIRE® SPOTFIRE® Respiratory/Sore Throat (R/ST) Panel Mini Verification Record- Sore Throat Menu

SPOTFIRE R/ST Mini Kit Part # _____ **Module Serial #** _____
SPOTFIRE R/ST Mini Kit Lot # _____ **Module Serial #** _____
Media Type _____ **Media Lot #** _____

Organism and Representative Strain		Replicate Testing- Record Organism Detections								Sore Throat Summary					
		1-E	1-F	1-G	1-H	2-E	2-F	2-G	2-H	# Positives	# Negatives	# Operators	# Days	# Modules	Patient Samples?
Pool 1	Positive: Multiple Organisms														
	Coronavirus SARS-CoV-2	N/A	N/A	N/A	N/A	N/A	N/A	N/A	N/A	N/A	N/A	N/A	N/A	N/A	N/A
	Human rhinovirus														
	Influenza A virus														
	subtype H1-2009														
	subtype H3														
	Influenza B virus														
Respiratory syncytial virus															
<i>Streptococcus pyogenes</i> (group A Strep)															
Pool 2	Negative														
	No organism detections														

Reviewed by: _____
 Signature

